

RECOMMENDED  
INSTALLATION  
TOOLING

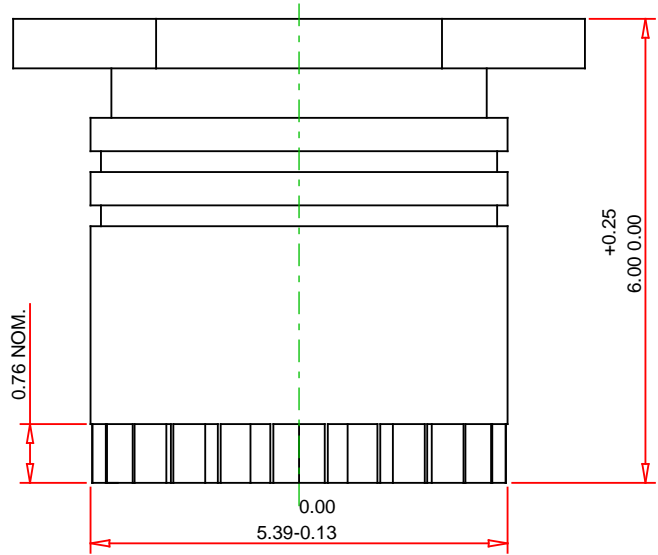
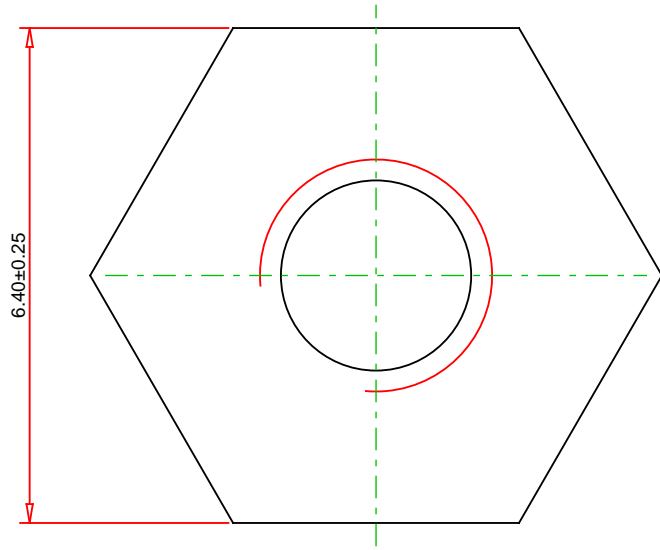
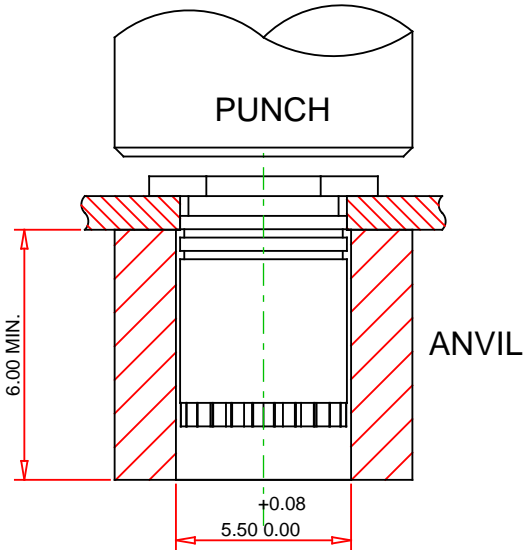

© 2019 PennEngineering

ALL DIMENSIONS IN MILLIMETERS

DATE 2-DEC-2019

NOTE : DRAWING NOT TO SCALE

THREAD : M3 x 0.5	MOUNTING HOLE DIA. : 5.40 +0.08 -0.00
MATERIAL: 300 SERIES STAINLESS STEEL	PANEL THICKNESS: 1.00 MINIMUM
HEAT TREAT: NONE	MAX. PANEL HARDNESS: HRB 70 / HB 125
FINISH: Passivated and/or tested per ASTM A380	MIN CENTERLINE-TO-EDGE: 6.8

DESCRIPTION :  
GROUNDING STANDOFFS - TYPES SOSG, SOAG - METRIC



PennEngineering®

PART NO. :  
SOSG-3.5M3-6

EMAIL: TECHSUPPORT@PEMNET.COM  
WWW.PEMNET.COM